



Positsioon	Kogus	Kirjeldus
	1	<p><b>UPS 25-40 N 180</b></p>  <p style="text-align: right;"><b>Märkus! Reaalse toote väljanägemine võib erineda pildil kujutatust.</b></p> <p>Toote kood:: <a href="#">96913060</a></p> <p>The pump is of the canned rotor type, i.e. pump and motor form an integral unit without shaft seal and with only two gaskets for sealing. The bearings are lubricated by the pumped liquid. The pump has 3-step speed selector. The pump is characterized by:</p> <ul style="list-style-type: none"> <li>* Ceramic shaft and radial bearings.</li> <li>* Carbon axial bearing.</li> <li>* Stainless steel rotor can and bearing plate.</li> <li>* Corrosion-resistant impeller, Komposiit, PES/PP.</li> <li>* Roostevaba teras pump housing.</li> </ul> <p>The motor is a 1-phase motor. No additional motor protection is required.</p> <p><b>Vedelik:</b></p> <p>Pumbatav vedelik: Veski Vedeliku temperatuurivahemik: 2 .. 110 °C Vedeliku temp.: 20 °C Tihedus: 998.2 kg/m<sup>3</sup></p> <p><b>Tehnilised:</b></p> <p>TF klass: 110 Tunnustused sildikul: CE, VDE, EAC</p> <p><b>Materjalid:</b></p> <p>Pumbapesa: Roostevaba teras DIN W.-Nr. 1.4301 Tööratas: Komposiit, PES/PP</p> <p><b>Paigaldamine:</b></p> <p>Keskond, maks.80oC vedel.korral: 40 °C Maks. töösurve: 10 bar Toruühendus: G 1 1/2 Surveklass: PN 10 Paigalduspikkus: 180 mm</p> <p><b>Elektriandmed:</b></p> <p>C töö: 1.5 µF Tarbitav võimsus 1. kiirusel: 25 W</p>

Positsioon	Kogus	Kirjeldus
		Tarbitav võimsus 2. kiirusel: 35 W Tarbitav võimsus 3. kiirusel: 45 W Vooluvõrgu sagedus: 50 Hz Nimipinge: 1 x 230 V Vool 1. kiirusel: 0.12 A Vool 2. kiirusel: 0.16 A Current in speed 3: 0.2 A Kondensaator - töö: 1.5 µF Kaitseklass (IEC 34-5): IP44 Isolatsiooniklass (IEC 85): F  <b>Muu:</b> Nettokaal: 2.9 kg Bruttokaal: 3.1 kg Tarnemaht: 0.004 m <sup>3</sup>



**96913060 UPS 25-40 N 180 50 Hz**

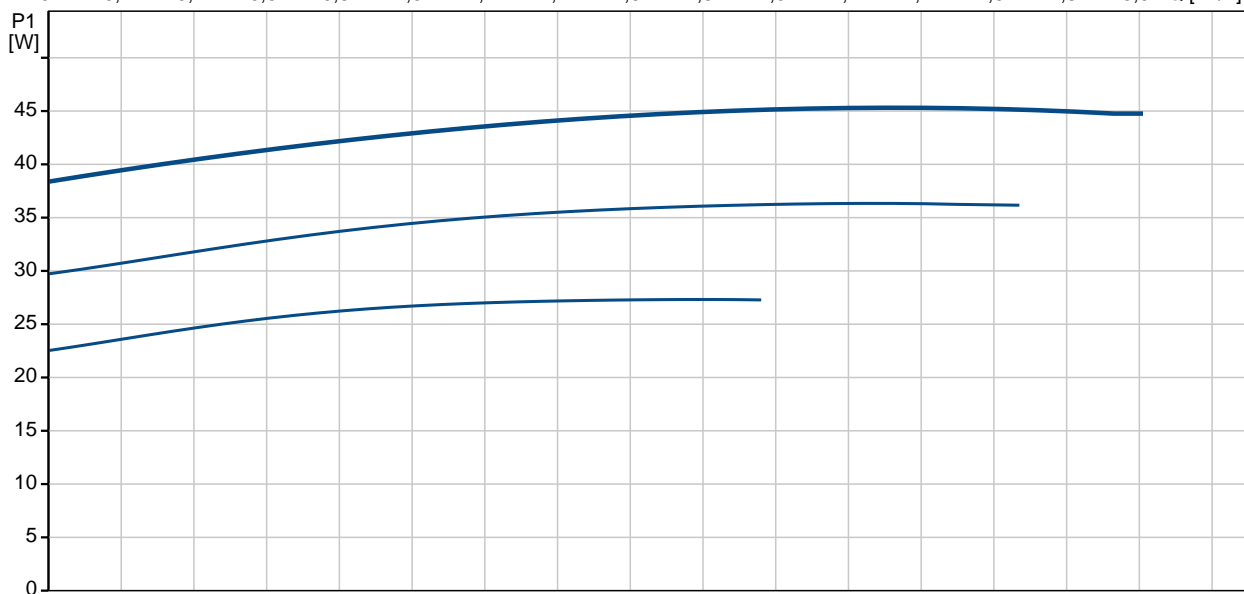
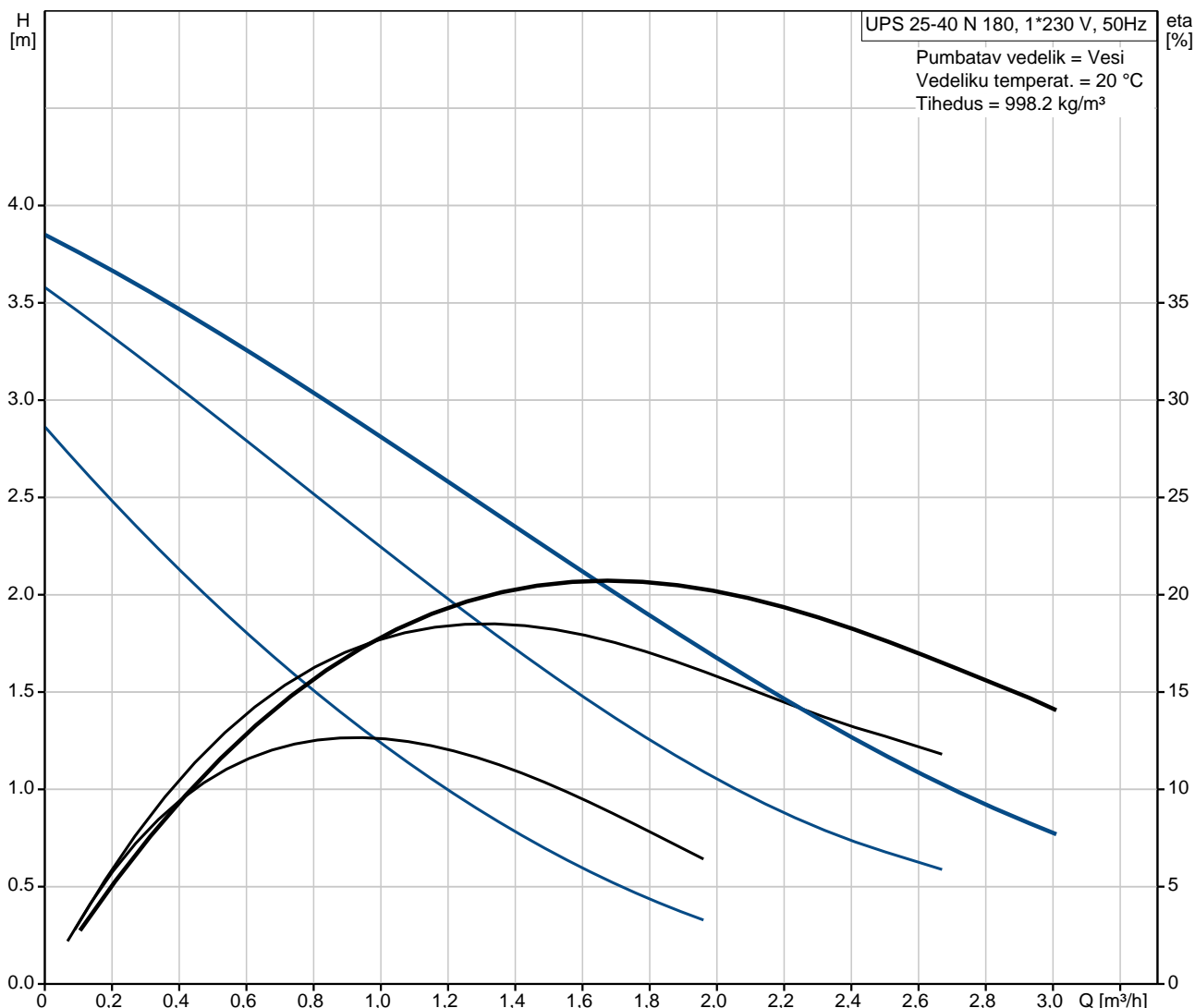

Kirjeldus	Väärtus
Product name:	UPS 25-40 N 180
Product No:	96913060
EAN number:	5700313543083
Hind:	Nõudmisel
<b>Tehnilised:</b>	
Kiirus nr.:	3
Tõstekõrgus maks.:	40 dm
TF klass:	110
Tunnustused sildikul:	CE,VDE,EAC
<b>Materjalid:</b>	
Pumbapesa:	Roostevaba teras DIN W.-Nr. 1.4301
Tööratas:	Komposiit, PES/PP
<b>Paigaldamine:</b>	
Keskond, maks.80oC vedel.korral:	40 °C
Maks. töösurve:	10 bar
Toruühendus:	G 1 1/2
Surveklass:	PN 10
Paigalduspikkus:	180 mm
<b>Vedelik:</b>	
Pumbatav vedelik:	Vesi
Vedeliku temperatuurivahemik:	2 .. 110 °C
Vedeliku temp.:	20 °C
Tihedus:	998.2 kg/m <sup>3</sup>
<b>Elektriandmed:</b>	
C töö:	1.5 µF
Tarbitav võimsus 1. kiirusel:	25 W
Tarbitav võimsus 2. kiirusel:	35 W
Tarbitav võimsus 3. kiirusel:	45 W
Vooluvõrgu sagedus:	50 Hz
Nimipinge:	1 x 230 V
Vool 1. kiirusel:	0.12 A
Vool 2. kiirusel:	0.16 A
Current in speed 3:	0.2 A
Kondensaator - töö:	1.5 µF
Kaitseklass (IEC 34-5):	IP44
Isolatsiooniklass (IEC 85):	F
Mootori kaitse:	NONE
Termokaitse:	Impedance protected
<b>Juhtimiseseade:</b>	
Klemmkarbi asend:	9H
<b>Muu:</b>	
Nettokaal:	2.9 kg
Bruttokaal:	3.1 kg
Tarnemaht:	0.004 m <sup>3</sup>

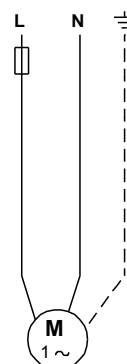
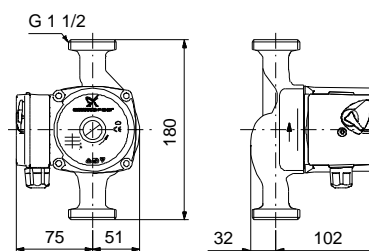
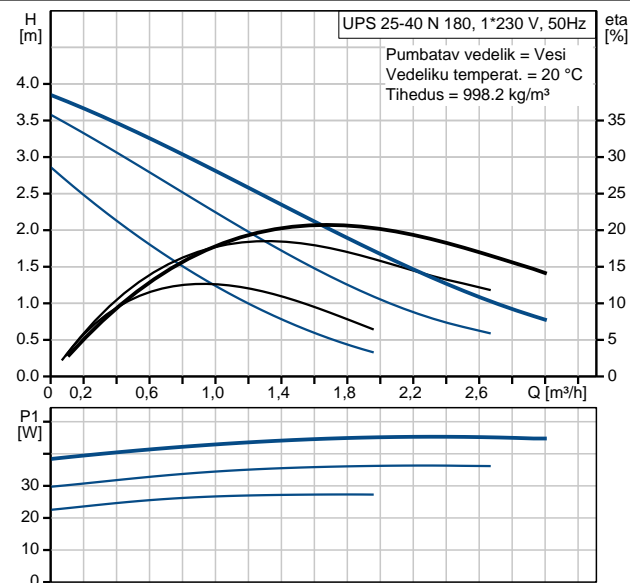



96913060 UPS 25-40 N 180 50 Hz

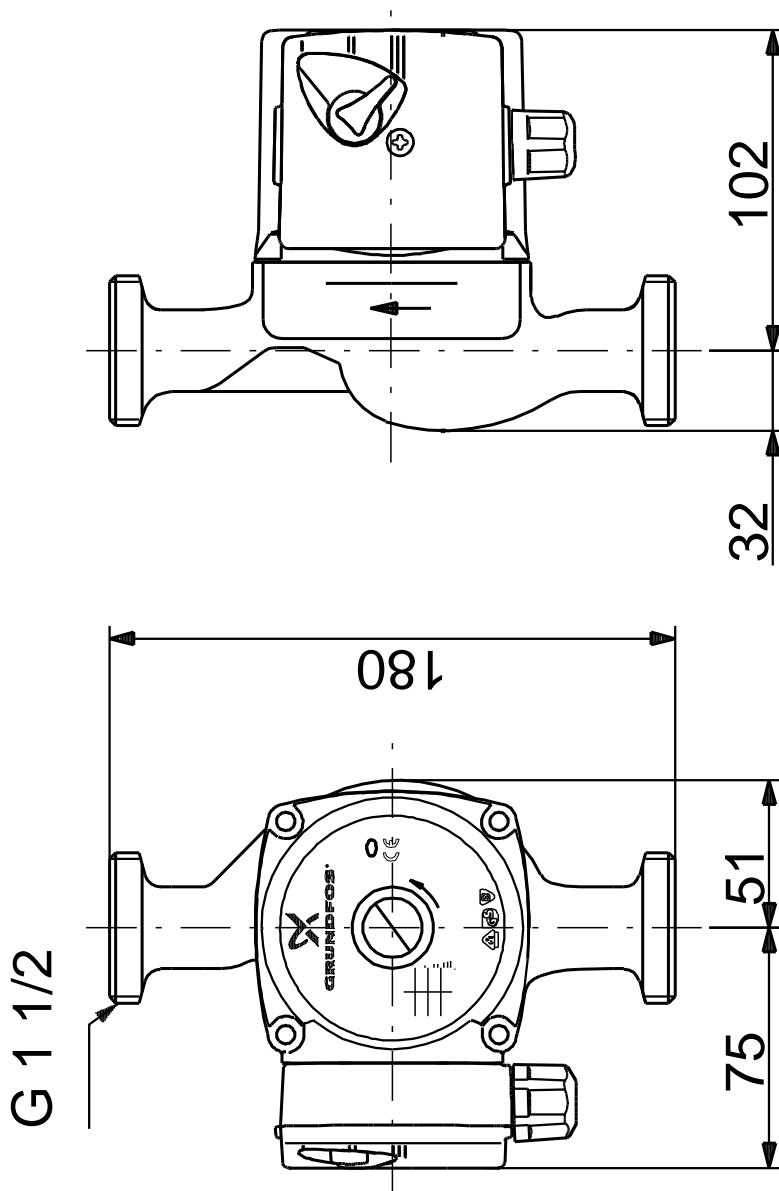

Note! All units are in [mm] unless others are stated.  
Disclaimer: This simplified dimensional drawing does not show all details.