



Positsioon	Kogus	Kirjeldus
	1	<p>MAGNA3 65-150 F</p>  <p style="text-align: right;">Märkus! Reaalse toote väljanägemine võib erineda pildil kujutatust.</p> <p>Toote kood:: 97924299</p> <p>MAGNA3 – More than a pump With its unrivalled efficiency, all-encompassing range and built-in communication capabilities plus functionalities replacing system components, the MAGNA3 is ideal for engineers and specifiers looking to create high-performance systems for buildings.</p> <p>This pump in the Grundfos Master Class will fit both heating and cooling applications perfectly, making it the obvious choice for almost any building project – old or new.</p> <p>The MAGNA3 is of the canned-rotor type, i.e. pump and motor form an integral unit without shaft seal and with only two gaskets for sealing. The bearings are lubricated by the pumped liquid.</p> <p>The innovative clamp with only one screw enables easy repositioning of the pump head. The MAGNA3 is a pump with no maintenance requirements and with extremely low Life Cycle Cost.</p> <p>The pump is characterised by the following:</p> <ul style="list-style-type: none"> • controller integrated in the control box • control panel with TFT display on the control box • control box prepared for optional CIM modules • built-in differential-pressure and temperature sensor • cast-iron pump housing (depending on model) • carbon-fibre-reinforced composite rotor can • stainless-steel bearing plate and rotor cladding • aluminium alloy stator housing • air-cooled power electronics <p>The MAGNA3 is a single-phase pump.</p> <p>Characteristic features</p> <ul style="list-style-type: none"> • AUTOADAPT. • FLOWADAPT and FLOWLIMIT (more than a pump function as it reduces the need for pump throttling valves). • Proportional-pressure control. • Constant-pressure control. • Constant-temperature control. • Constant-curve duty. • Max. or min. curve duty. • Automatic Night Setback. • No external motor protection required. • Insulating shells supplied with single-head pumps for heating systems. • Large temperature range where the liquid temperature and the ambient temperature are independent of each other.

Positsioon	Kogus	Kirjeldus
		<p>Communication</p> <p>The MAGNA3 enables communication via the following:</p> <ul style="list-style-type: none"> • wireless Grundfos GO Remote • fieldbus communication via CIM modules • digital inputs • relay outputs • analog input (more than a pump function as heat energy meter) <p>Motor and electronic controller</p> <p>The MAGNA3 incorporates a 4-pole synchronous, permanent-magnet motor (PM motor). This motor type is characterised by higher efficiency than a conventional asynchronous squirrel-cage motor.</p> <p>The pump speed is controlled by an integrated frequency converter.</p> <p>A differential-pressure and temperature sensor is incorporated in the pump.</p> <p>Vedelik:</p> <p>Pumbatav vedelik: Vesi Vedeliku temperatuurivahemik: -10 .. 110 °C Vedeliku temp.: 20 °C Tihedus: 998.2 kg/m³</p> <p>Tehnilised:</p> <p>TF klass: 110 Tunnustused sildikul: CE,VDE,EAC</p> <p>Materjalid:</p> <p>Pumbapesa: Valumalm EN-GJL-250 ASTM A48-250B</p> <p>Tööratas: PES 30%GF</p> <p>Paigaldamine:</p> <p>Ümbritseva temperat. vahemik: 0 .. 40 °C Maks. töösurve: 10 bar Ääriku standard: DIN Toruühendus: DN 65 Surveklass: PN6/10 Paigalduspikkus: 340 mm</p> <p>Elektriandmed:</p> <p>Power input - P1: 29 .. 1301 W Maksimaalne voolutarve: 0.3 .. 5.68 A Vooluvõrgu sagedus: 50 Hz Nimipinge: 1 x 230 V Kaitseklass (IEC 34-5): X4D Isolatsiooniklass (IEC 85): F</p> <p>Muu:</p> <p>Label: Grundfos Blueflux Energy (EEI): 0.17 Nettokaal: 24.6 kg Bruttokaal: 26.8 kg Tarnemaht: 0.057 m³</p>



97924299 MAGNA3 65-150 F 50 Hz

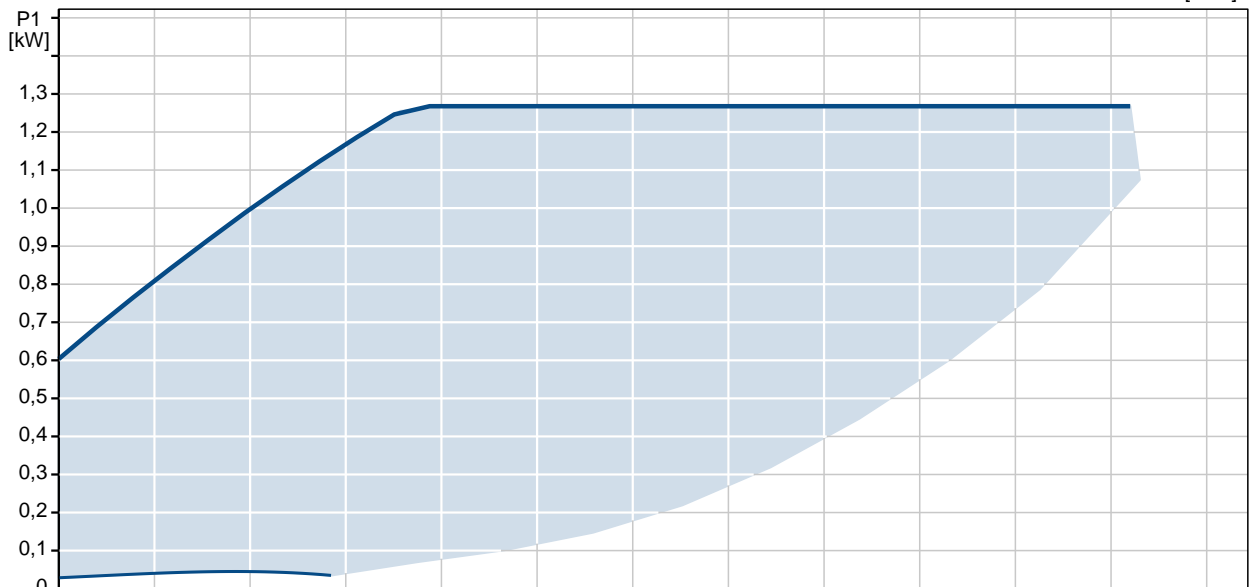
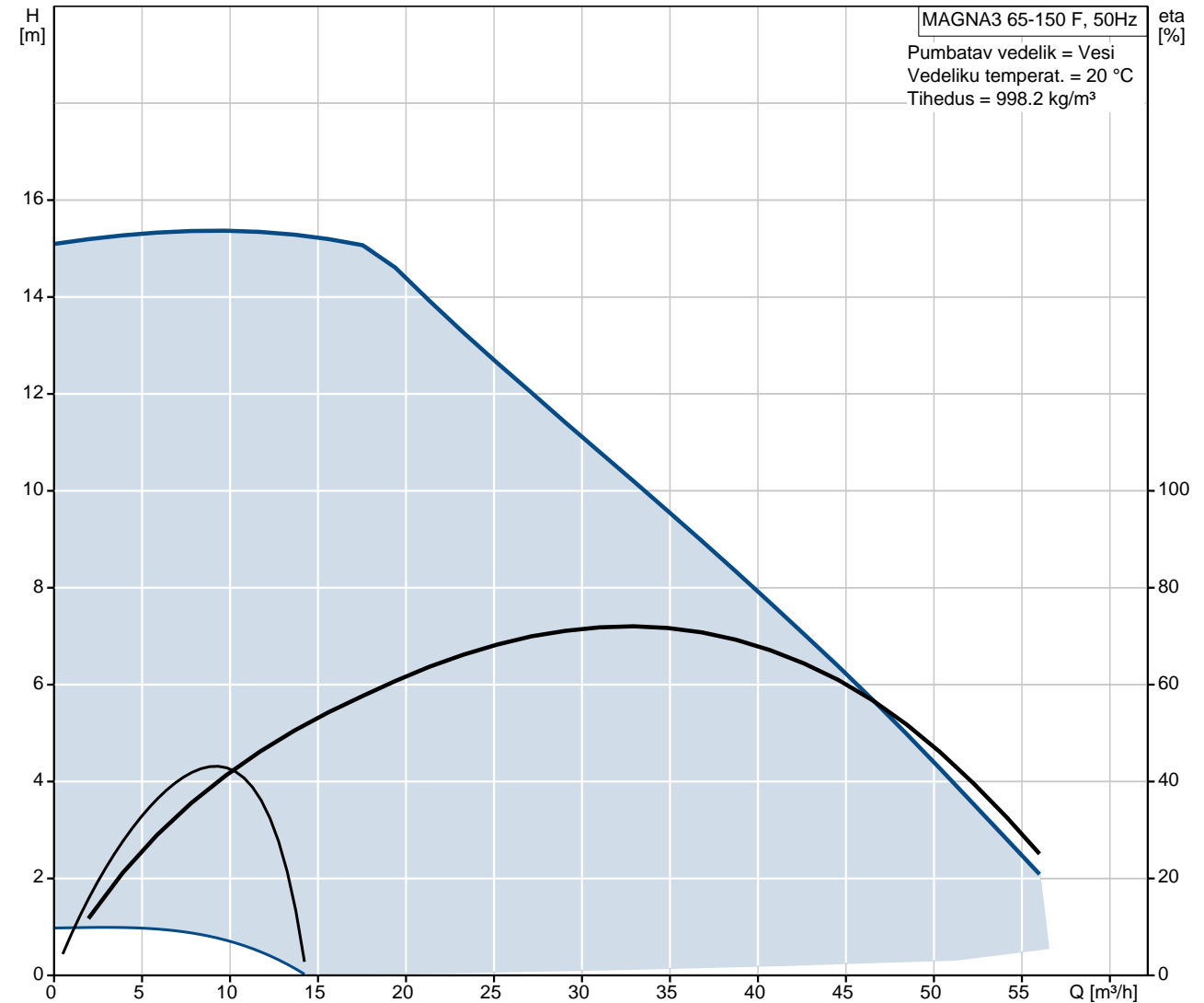

Kirjeldus	Väärtus
Product name:	MAGNA3 65-150 F
Product No:	97924299
EAN number:	5710626493746
Hind:	Nõudmisel

Tehnilised:	
Tõstekõrgus maks.:	150 dm
TF klass:	110
Tunnustused sildikul:	CE, VDE, EAC
Mudel:	A

Materjalid:	
Pumbapesa:	Valumalm EN-GJL-250 ASTM A48-250B
Tööratas:	PES 30%GF

Paigaldamine:	
Ümbritseva temperat. vahemik:	0 .. 40 °C
Maks. töösurve:	10 bar
Ääriku standard:	DIN
Toruühendus:	DN 65
Surveklass:	PN6/10
Paigalduspikkus:	340 mm

Vedelik:	
Pumbatav vedelik:	Vesi
Vedeliku temperatuurivahemik:	-10 .. 110 °C
Vedeliku temp.:	20 °C
Tihedus:	998.2 kg/m ³

Elektriandmed:	
Power input - P1:	29 .. 1301 W
Maksimaalne voolutarve:	0.3 .. 5.68 A
Vooluvõrgu sagedus:	50 Hz
Nimipinge:	1 x 230 V
Kaitseklass (IEC 34-5):	X4D
Isolatsiooniklass (IEC 85):	F

Muu:	
Label:	Grundfos Blueflux
Energy (EEI):	0.17
Nettokaal:	24.6 kg
Bruttokaal:	26.8 kg
Tarnemaht:	0.057 m ³

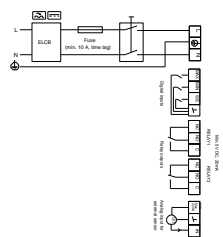
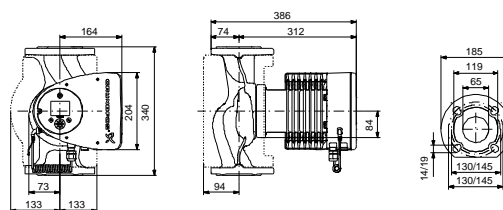
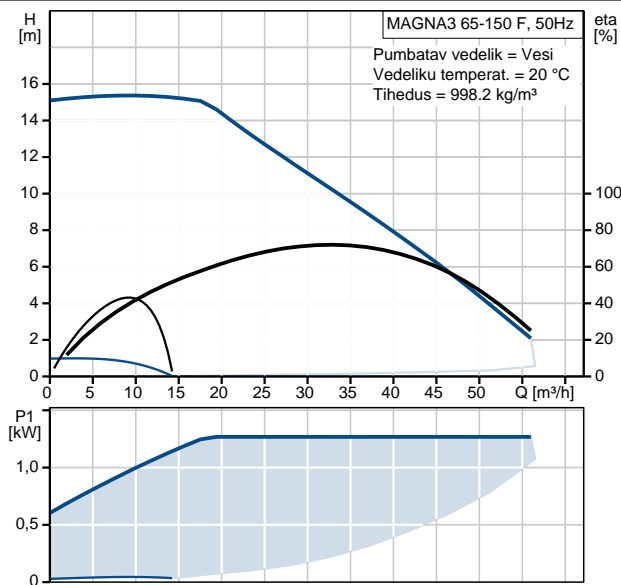

97924299 MAGNA3 65-150 F 50 Hz

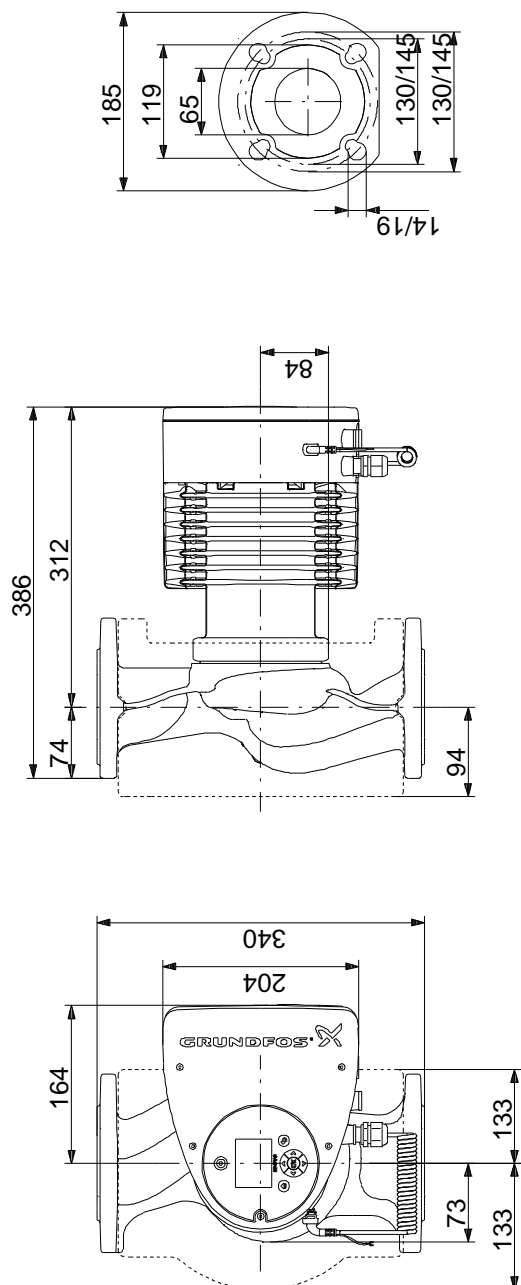

Note! All units are in [mm] unless others are stated.
Disclaimer: This simplified dimensional drawing does not show all details.