



Positsioon	Kogus	Kirjeldus
	1	<p>MAGNA1 25-100</p>  <p>Märkus! Reaalse toote väljanägemine võib erineda pildil kujutatust.</p> <p>Toote kood:: 97924145</p> <p>MAGNA1 circulator pump with easy selection of pump setting The pump is of the canned-rotor type, i.e. pump and motor form an integral unit without shaft seal and with only two gaskets for sealing. The bearings are lubricated by the pumped liquid. In order to avoid problems in connection with disposal, great importance has been attached to using as few different materials as possible. A pump with no maintenance requirements and extremely low life cycle cost.</p> <p>Heating systems</p> <ul style="list-style-type: none"> • Main pump • mixing loops • heating surfaces • air-conditioning surfaces. <p>The MAGNA1 circulator pumps are designed for circulating liquids in heating systems with variable flows where it is desirable to optimise the setting of the pump duty point, thus reducing energy costs. The pumps are also suitable for domestic hot-water systems.</p> <p>To ensure correct operation, it is important that the sizing range of the system falls within the duty range of the pump.</p> <p>Benefits</p> <ul style="list-style-type: none"> • Safe selection. • Simple installation. • Low energy consumption. All MAGNA1 pumps comply with the EuP requirements. • Nine light fields for indication of pump setting. Three proportional-pressure curves, three constant-pressure curves and three fixed-speed curves are available. • Low noise level. • No maintenance and long life. <p>Vedelik:</p> <p>Pumbatav vedelik: Vesi Vedeliku temperatuurivahemik: -10 .. 110 °C Vedeliku temp.: 20 °C Tihedus: 998.2 kg/m³</p> <p>Tehnilised:</p> <p>TF klass: 110</p>



Positsioon	Kogus	Kirjeldus
		<p>Tunnustused sildikul: CE,VDE,EAC</p> <p>Materjalid:</p> <p>Pumbapesa: Valumalm EN-GJL-200 ASTM A48-200B</p> <p>Tööratas: PES 30%GF</p> <p>Paigaldamine:</p> <p>Ümbritseva temperat. vahemik: 0 .. 40 °C Maks. töösurve: 10 bar Toruühendus: G 1 1/2" Surveklass: PN10 Paigalduspikkus: 180 mm</p> <p>Elektriandmed:</p> <p>Power input - P1: 9 .. 176 W Maksimaalne voolutarve: 0.09 .. 1.42 A Vooluvõrgu sagedus: 50 Hz Nimipinge: 1 x 230 V Kaitseklass (IEC 34-5): X4D Isolatsiooniklass (IEC 85): F</p> <p>Muu:</p> <p>Label: Grundfos Blueflux Energy (EEL): 0.22 Nettokaal: 4.38 kg Bruttokaal: 4.78 kg Tarnemaht: 0.012 m³</p>



97924145 MAGNA1 25-100 50 Hz

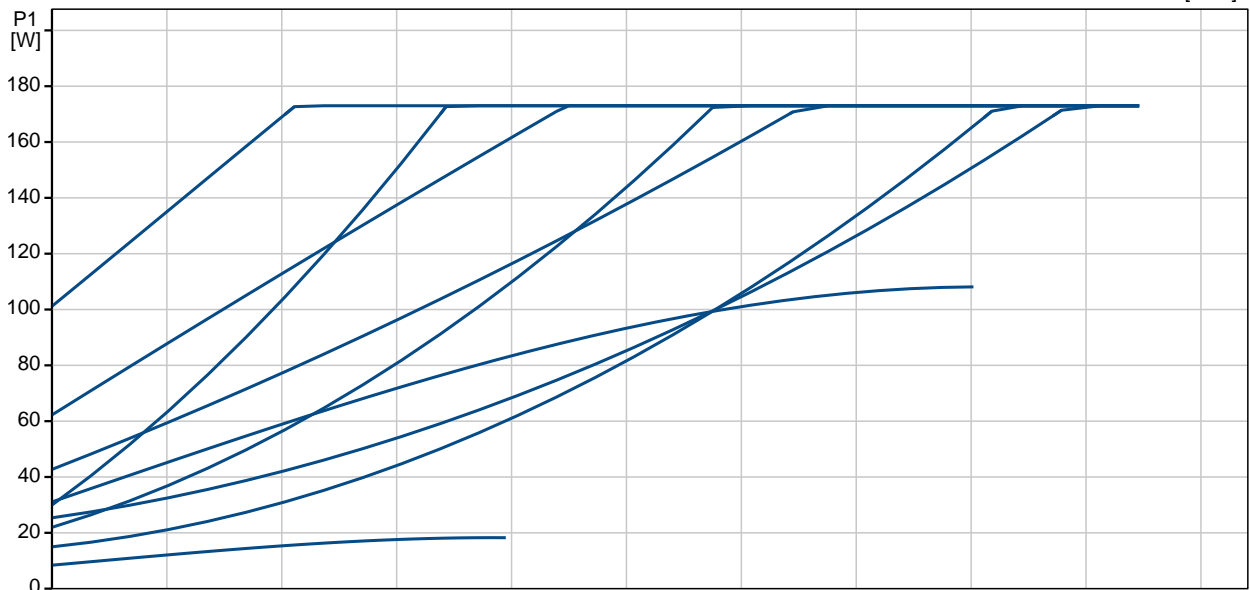
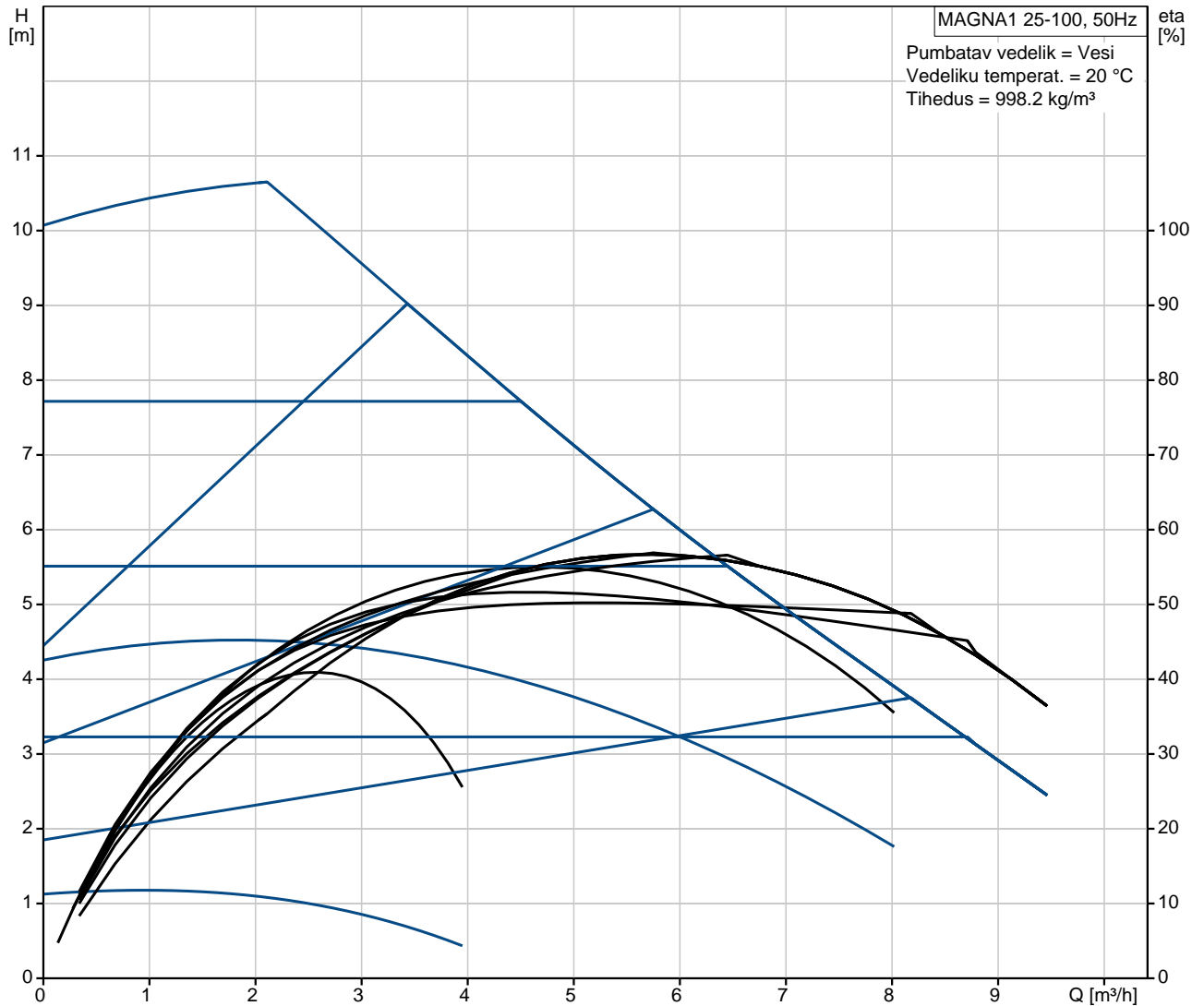

Kirjeldus	Väärtus
Product name:	MAGNA1 25-100
Product No:	97924145
EAN number:	5710626492190
Hind:	Nõudmisel
Tehnilised:	
Tõstekõrgus maks.:	100 dm
TF klass:	110
Tunnustused sildikul:	CE, VDE, EAC
Mudel:	A
Materjalid:	
Pumbapesa:	Valumalm EN-GJL-200 ASTM A48-200B
Tööratas:	PES 30%GF
Paigaldamine:	
Ümbritseva temperat. vahemik:	0 .. 40 °C
Maks. töösurve:	10 bar
Toruühendus:	G 1 1/2"
Surveklass:	PN10
Paigalduspikkus:	180 mm
Vedelik:	
Pumbatav vedelik:	Vesi
Vedeliku temperatuurivahemik:	-10 .. 110 °C
Vedeliku temp.:	20 °C
Tihedus:	998.2 kg/m ³
Elektriandmed:	
Power input - P1:	9 .. 176 W
Maksimaalne voolutarve:	0.09 .. 1.42 A
Vooluvõrgu sagedus:	50 Hz
Nimipinge:	1 x 230 V
Kaitseklass (IEC 34-5):	X4D
Isolatsiooniklass (IEC 85):	F
Muu:	
Label:	Grundfos Blueflux
Energy (EEI):	0.22
Nettokaal:	4.38 kg
Bruttokaal:	4.78 kg
Tarnemaht:	0.012 m ³

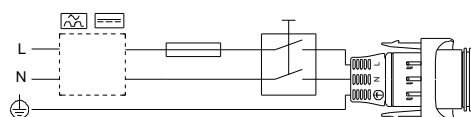
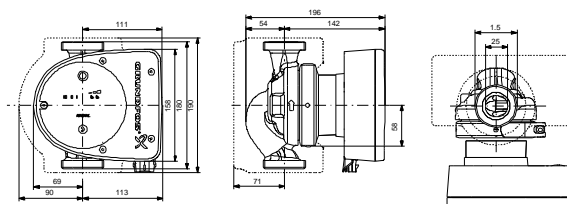
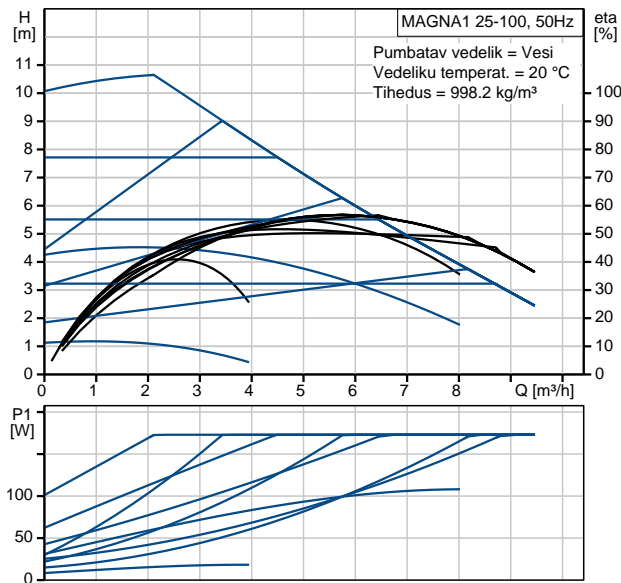

97924145 MAGNA1 25-100 50 Hz

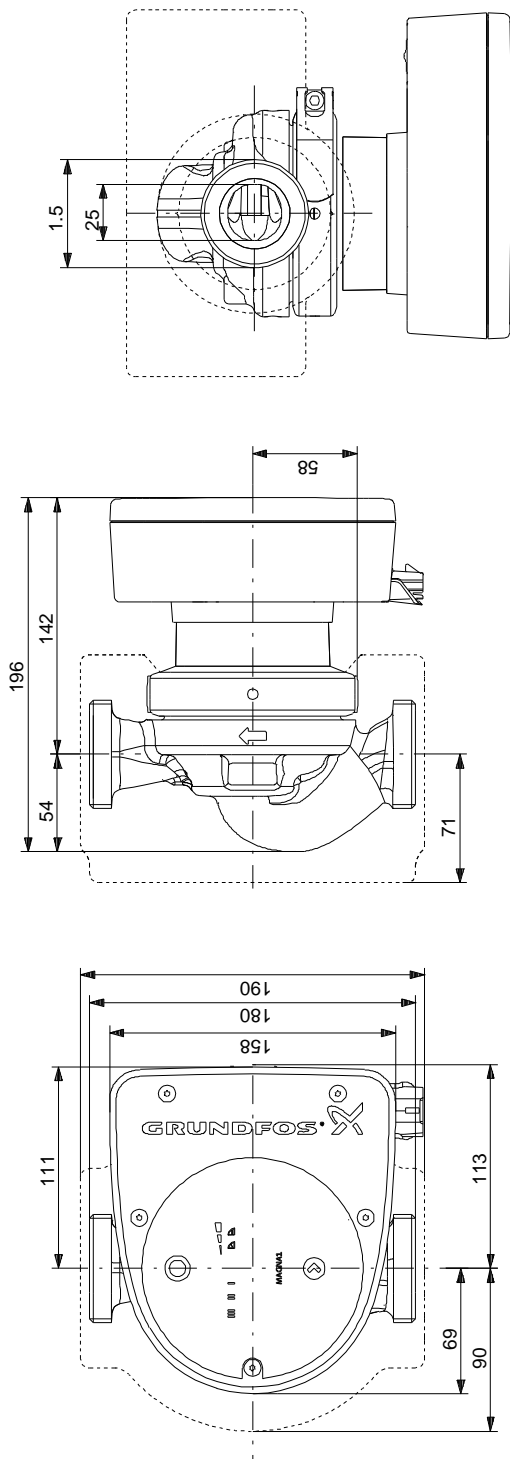

Note! All units are in [mm] unless others are stated.
Disclaimer: This simplified dimensional drawing does not show all details.